

Notched Bearer Deck Kit 3M Assembly Instructions

HARTLEBURY TRADING ESTATE
HARTLEBURY, WORCS DY10 4JB
TELEPHONE 0844 248 9853

Issue 0108

Thank you for choosing this deck kit from Larch Lap, the U.K.'s largest manufacturer of timber garden products. In order to gain the most benefit from it, please note the following :

- 1) Please take time to read the assembly instructions carefully before erecting the deck, and check all parts prior to assembly. Neither refunds nor replacements can be offered if the structure is incorrectly assembled.
- 2) Whilst we will replace any damaged or defective parts free of charge, we cannot accept any parts that have been modified from their original condition, eg. drilled, sawn or painted.
- 3) All holes should be pre-drilled in order to prevent wood from splitting.
- 4) Please take care to keep all plastic bags and small parts away from children to minimise the risk of suffocation.

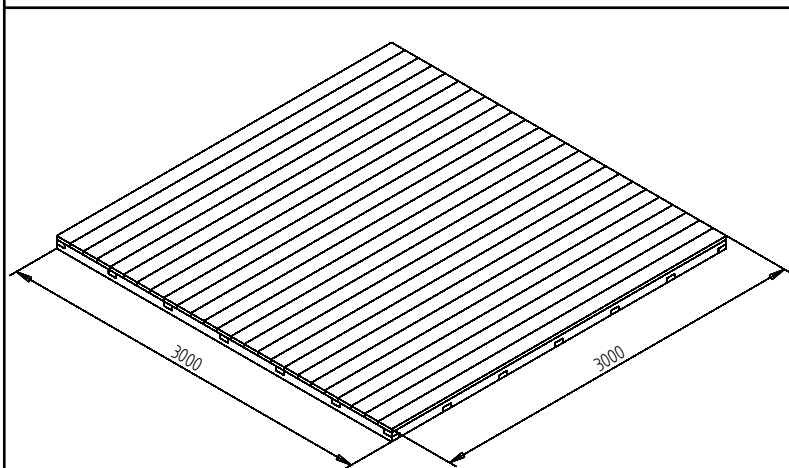

Important : Assembly of this deck requires two people.
Assembly should take approximately 1/2 a day.

Fixings Included

NBDK30FP

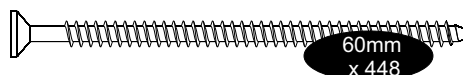

Helpful Tip : use the illustration of the screw shown in each step to help you identify which fixing is required for each step in the assembly of your deck.

Required Tools : (Not Supplied)



DRILL



POZI DRIVE SCREWDRIVER



TAPE MEASURE



SPIRIT LEVEL

Components Included

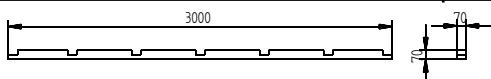

FSDB10PTR QTY 14

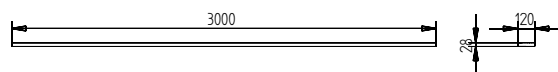

PATDB3MBI QTY 25

1

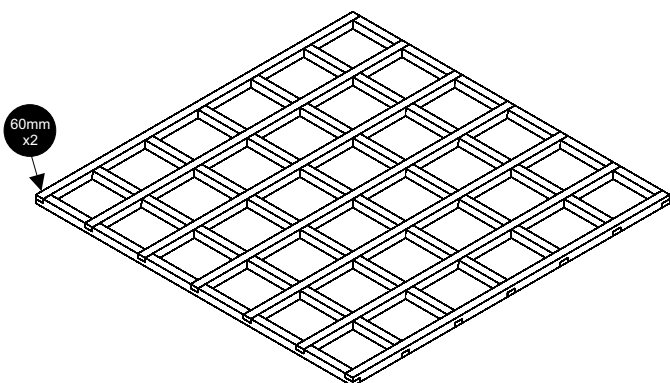

Interlock notches of bearers. Secure together at each intersection with two 60mm screws.

2

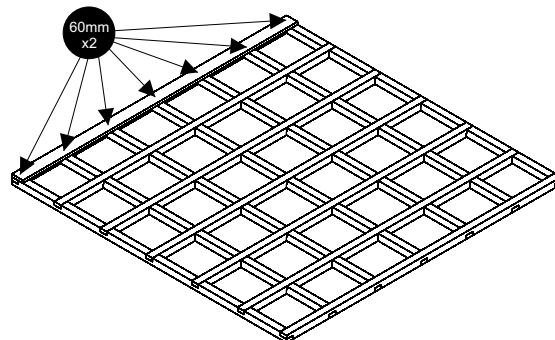

Place a deck board on top of the base and secure it to each bearer with two 60mm screws.

3

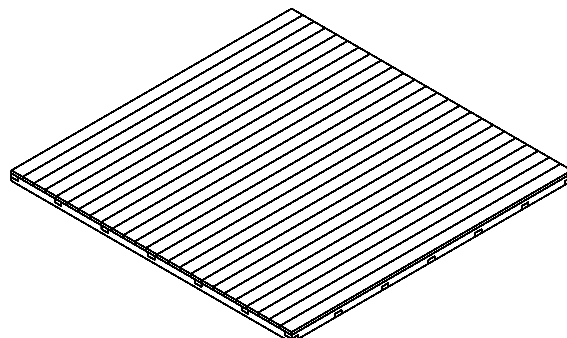

Repeat procedure with remaining deck boards to complete deck.

Should you require any additional guidance with the assembly of your deck please contact our technical help line on 0844 248 9853 between the hours of 8:30am and 5:00pm Monday-Friday.